



Building Products Limited



■
Korniche
roof lantern
transform
your space







simply better in every way



Industry leading engineering design injects even more innovation into the evolution of our multi award winning glazed roof. Light up your world with the all **NEW** Korniche roof lantern

Slimmer. Warmer. Simply Better.

Home Improvement is a process which never stops.

Simply by looking at this brochure it's clear then that you are a person that is looking for progression, and progress is impossible without change.

In 2017 Korniche changed the direction of the industry with our revolutionary roof lantern and now we're doing it again with the evolution of the product.

We've made the best better because we understand that there should be no such thing as compromise when it comes to your dream home.

Building on our experience of 8 years leading the market we have evaluated every aspect of the Lantern product and improved every last one of them.

We bring you the most advanced Roof Lantern on the market. The all **NEW** Korniche roof lantern.

Revised design features improve heat retention, security, functionality, and aesthetic appeal, so you can enjoy a final product which is stronger, slimmer, warmer and easier to install than ever before.

continuous improvement

A Korniche roof lantern doesn't just change the way your living space looks with its strong, slender aesthetic.

Clear glass spans bathe rooms in natural light, transforming their function and the way they feel.

Strength with elegance

Enjoy the most expansive views possible with industry-leading glass spans. Korniche supports more glass with less structure, letting natural light better enhance your décor whilst energizing and improving your well-being.

The NEW Korniche roof lantern structural elements have been completely redesigned with the hips and ridges tapering down to a clean contemporary aesthetic. Slender external top caps complement the internal looks of the roof as the lines flow effortlessly down to the sculpted corners.

Each element has been optimised to be stronger and stiffer than ever before. Form and function meet perfectly achieving a premium finish.

Bespoke as standard

Reminiscent of a timber structure hand crafted by an expert, the aluminium Korniche roof is an affordable modern take on a timeless design classic.

Aluminium construction allows for an automated precision manufacturing process, where a high level of bespoke can surprisingly come as standard.

The Korniche roof lantern system can be specified in a range of configurations, colours and finishes, and that's before you even start to choose your favourite glass.

If you want a colour we don't list, no problem. Just let us know and we will find the perfect match for you.





Meticulously engineered to be the strongest and stiffest on the market, it supports more glass without the need for additional rafters.

engineered for efficiency

Climate control

We believe that everybody has a responsibility to reduce their footprint on our environment. The Korniche design team are dedicated to ensuring new products exceed standards and have a positive impact on the future of our planet.

The Korniche roof lantern has been designed with improved thermal performance at the top of the brief. A high strength polymer heart of insulation runs through the entire structure. A true thermal break, keeping the cold external parts isolated from the warm internal ones.

Fully thermally isolated fasteners complete the extensive insulation.

High performance argon filled glass units with engineered coatings provide the latest technology in insulation, minimizing heat transfer whilst letting in light, blocking UV and reflecting the heat of the sun.

Our changing environment is giving our homes a harder time keeping wind and rain out and the Korniche lantern is a step up when it comes to sealing and jointing technologies.

Everything starts at installation with our advanced pre-tensioning system designed to eliminate gaps within the completed structure. Once fully tight and screwed down, sealant - required only for the base seal, is injected into a dedicated groove and into ports at the corners where ducts carry the exact quantity to exactly where it's needed.

Custom glazing seals manufactured from TPE, finned or with closed cell foam completely encase the glass unit where profiles meet.

Bespoke individual and over-moulded seals finish the total closure with no reliance on liquid sealant within the structure.

Fastest, simplest installation

Making the complicated simple takes real creativity and making the fastest faster is all about marginal gains. By reducing components and therefore steps needed to fit, we've managed to increase the efficiency of installation.

Our expertly engineered roof lantern has boasted the fastest install time on the market since its inception. Our high-tech manufacturing system does all the hard work so all that's left is a simple to build kit.

Delivered with a comprehensive installation manual containing easy to follow step-by-step instructions, means the lantern can be installed in minutes and literally glazed in seconds.

The sheer simplicity of the installation and the elimination of any on site cutting/drilling/fettling, ensures a safe, quick, secure, and crucially, repeatable end result. You can guarantee a perfect finish with Korniche.

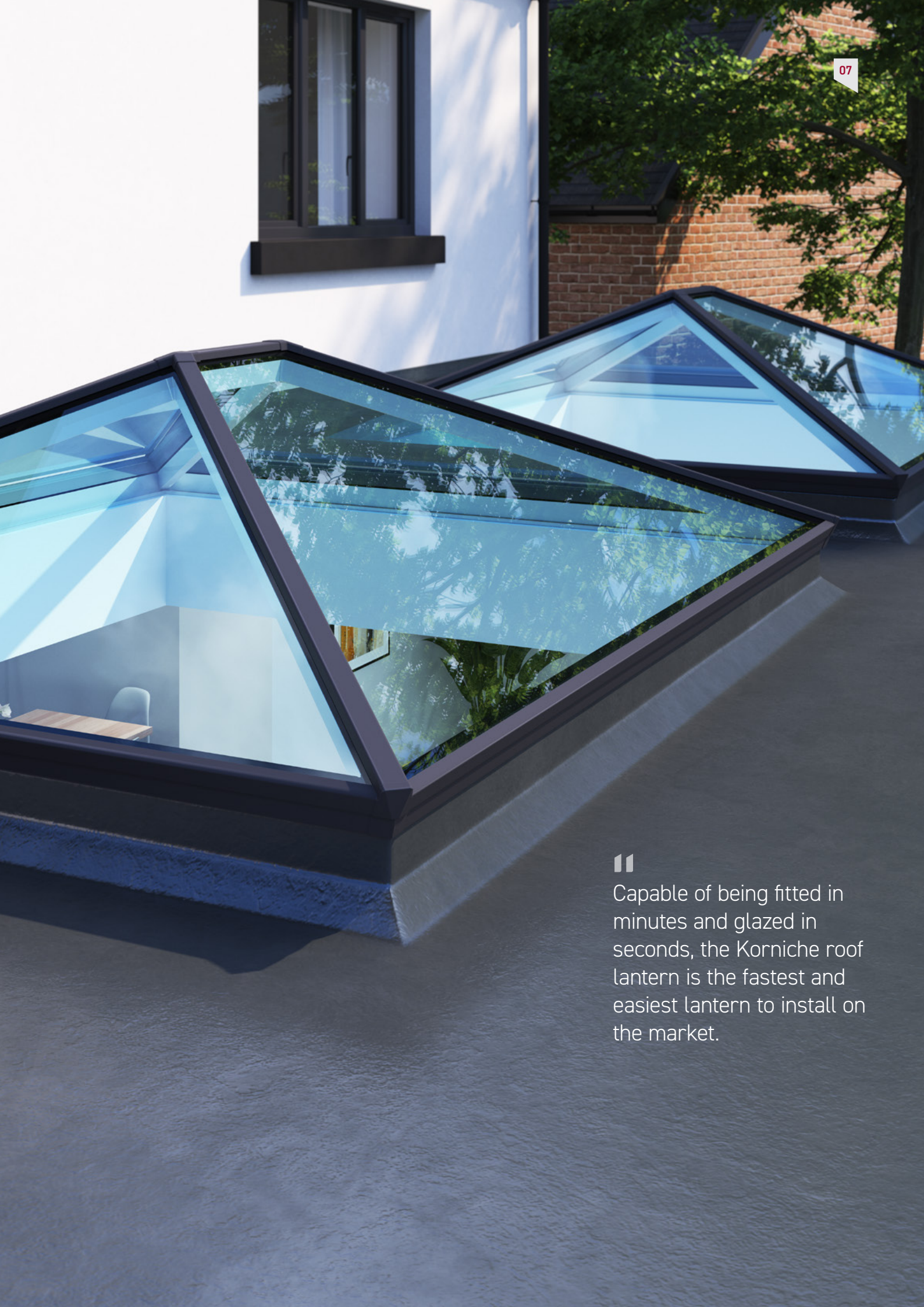

Capable of being fitted in minutes and glazed in seconds, the Korniche roof lantern is the fastest and easiest lantern to install on the market.



a **light** in the dark



Fully integrated LED lighting

The Korniche roof lantern is a powerful focal point of your room during the daylight hours, and now you can continue enjoying that visual impact long after the sun goes down.

Specify your lantern with our fully integrated dimmable LED lighting and matched diffusing lens. Your Korniche lantern will take on a totally different ambiance as night falls.

Uplighting is an effective way of highlighting key architectural features and the structure of the Korniche Lantern benefits immeasurably from this simple addition.

The custom lens clips cleanly over the top of the LED strip hiding it entirely when switched off and diffusing it beautifully when switched on.





With bespoke sizes and colours all you need to do is decide on the right combination for your vision.

Specifications

- Bespoke sizes up to 6m x 4m
- Fixed 25°pitch
- 28mm double glazed units
- Largest rectangular lantern with only 4 glass units: 3m x 2.5m (external size)
- Largest overall rectangular lantern size: 6m x 4m (external size)
- Largest Pyramid lantern with only 4 glass units: 2.5m x 2.5m (external size)
- Largest Pyramid lantern: 4m x 4m (external size)

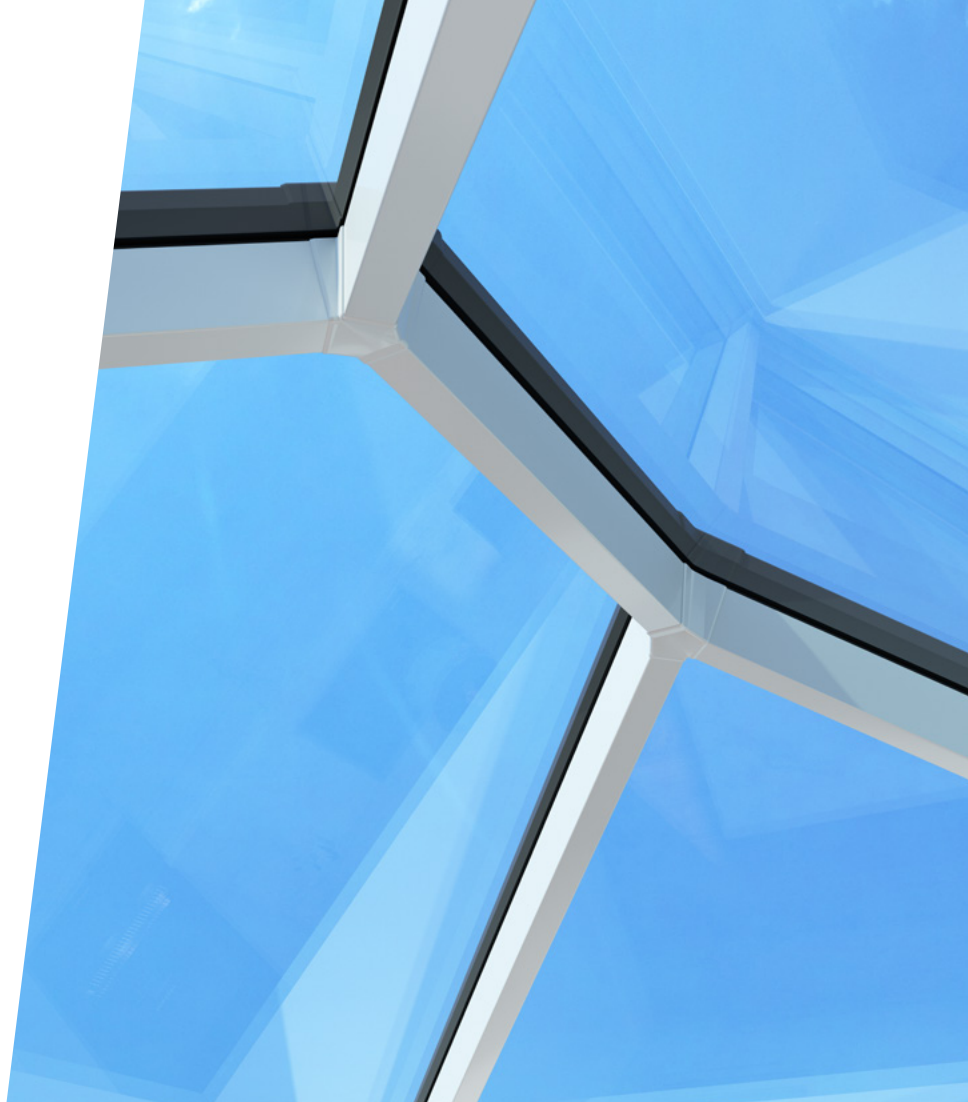

Available configurations

The Korniche Roof Lantern offers a range of options to suit your specific requirements. Different sizes and finishes with various glazing options, you can create a roof lantern that perfectly complements a projects unique style and architecture.

Configurations are available in pyramid and rectangular designs.

With Korniche, you have the freedom to personalise your living space and make it your own.

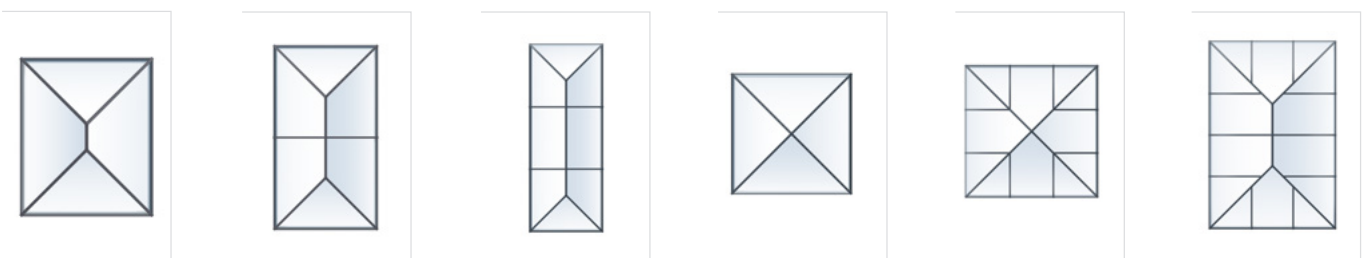

Colour options

- Three stock RAL colours
 - RAL 9910 - Gloss White
 - RAL 7016 - Matt Grey
 - RAL 9005 - Matt Black
- Dual colour available at no extra cost when selecting two stock colours
- Bespoke RAL and BS colours available

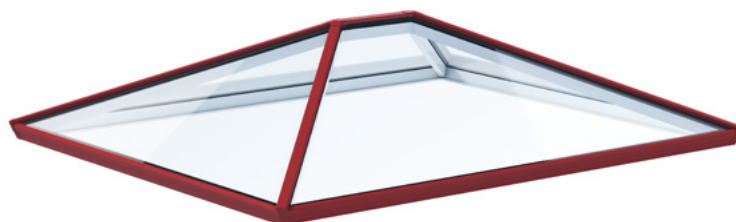
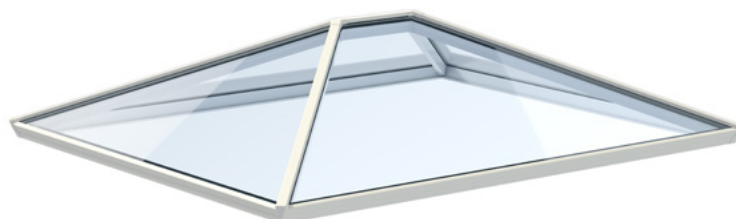
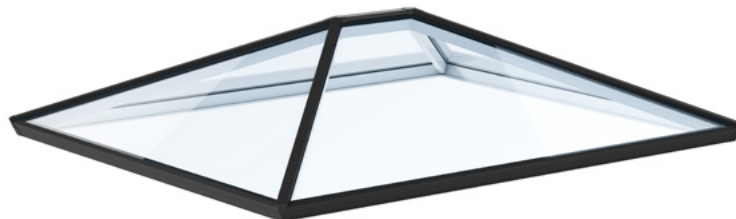
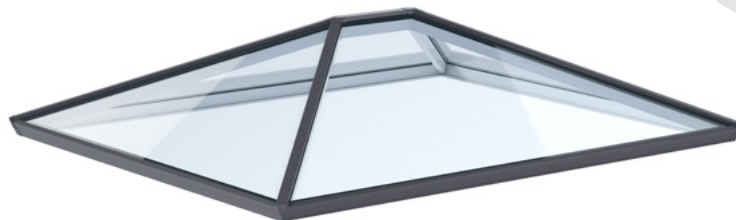
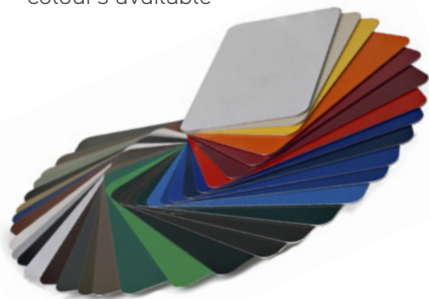

BESPOKE COLOURS AVAILABLE

Performance, self cleaning glazing options

All double glazed units are 28mm, argon gas filled sealed with a sleek warm edge spacer bar.

If the position of the roof lantern is south facing with direct sun, consider a glass type with a higher percentage of solar heat reflection and lower light transmission percentage to reduce solar gain.

U Values explained

The U Value is the rate at which heat is conducted across an insulated glass unit. The lower a number, the better a glass unit is at resisting heat transfer.

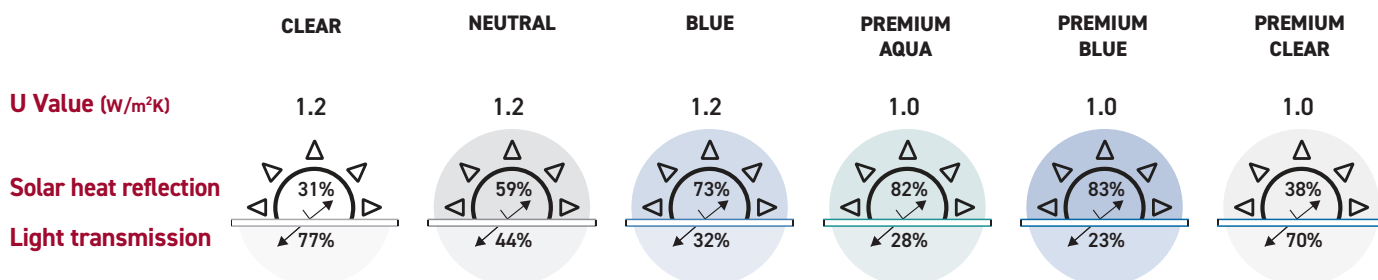

- Laminated and Privacy glass options available.

low maintenance: what you need to know

The Korniche Lantern is fabricated solely in the UK, in a dedicated manufacturing facility, ensuring exceptional quality and finishing standards.

When specified and installed in line with our product guidelines, your Korniche Lantern will require minimum maintenance for maximum peace of mind.

All components are CNC cut and machined with rigorous quality control checks ensuring a perfect finish.

Powder coating

The lantern's powder coated exterior doesn't just offer a wide range of colours, it also delivers a thick and consistently smooth finish which is extremely durable providing resistance to corrosion and damage from the elements.

Self-clean glass

Specially designed to remain cleaner for longer, our self-cleaning glass features a transparent coating that breaks down dirt using the sun's ultra-violet rays, which is then washed away by rainfall.

The durable coating is integrated into the external surface of the glass. It will still require the occasional clean in line with the glass manufacturer's instructions, but at far longer intervals compared to standard glass.



New product highlights

New design features work together to provide improvements in aesthetics, thermal performance, security and repeatability.

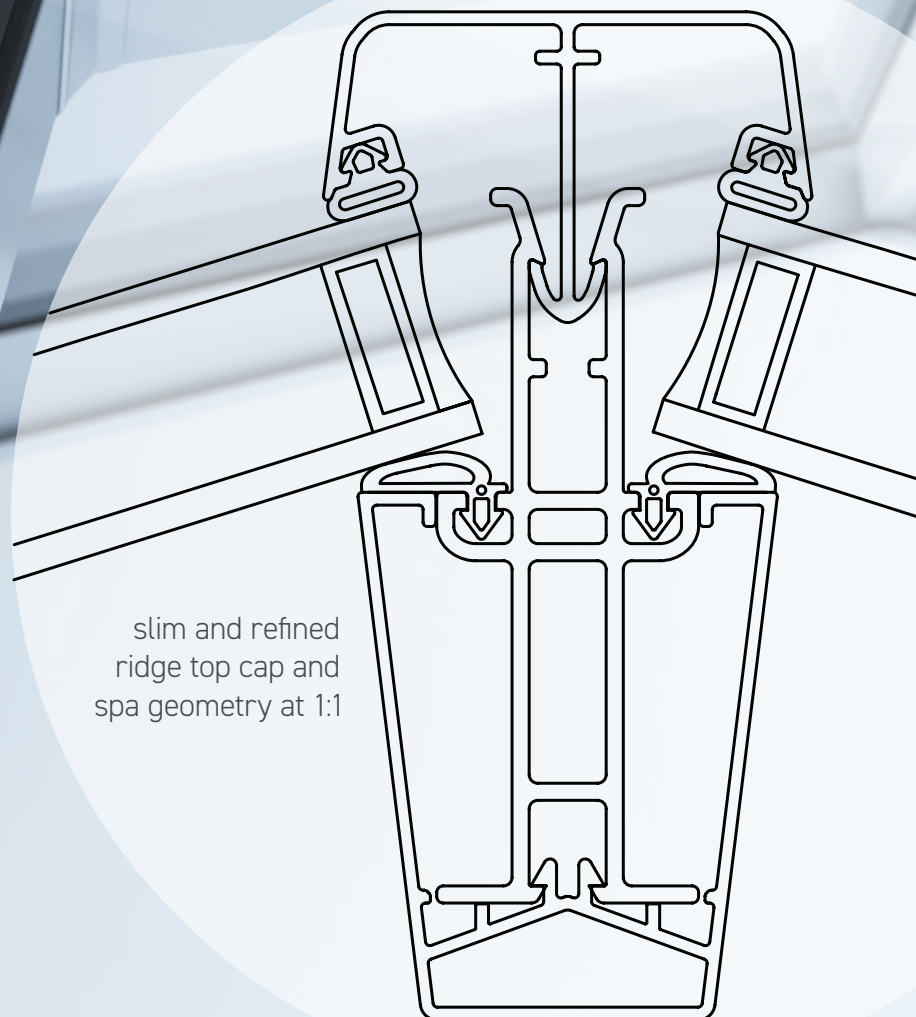

slim and refined
ridge top cap and
spa geometry at 1:1

Unique spar tensioning system

A tighter structure means even cleaner lines for the already precision machined roof. The unique to Korniche tensioning system pulls everything together perfectly to eliminate gaps and improve looks, weathertightness and strength.

Slimmer contemporary looks

- Reduced width ridge, hips and rafters with taper design for minimal sightlines
- Narrow top and end caps perfectly complement the slimmer profiles.
- Contemporary look with Korniche curve feature

Increased thermal performance

- Higher volume of thermally insulating material
- Wider multichambered thermal breaks
- Advanced glass coatings

Better protection

- Re-designed entirely bespoke gasket systems for total closure
- PAS24 high security as standard
- Requires Korniche tool (supplied with assembly parts) to de-glaze

Integrated lighting

- The neatest possible solution for highlighting your roof in low light

Faster, Simpler installation

- Simplified fitting process with less fasteners, less steps. No experience necessary
- Improved integrity sealing onto upstand

An established supplier that cares

- 40 year track record in the industry
- Recyclable packaging
- Gold standard customer service
- 10-year home owner warranty

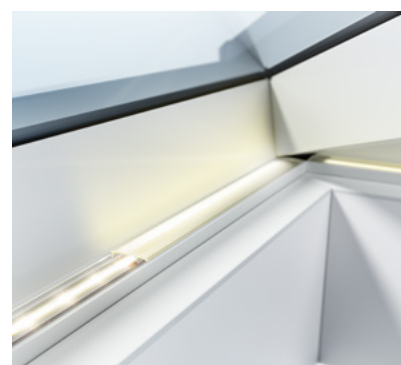
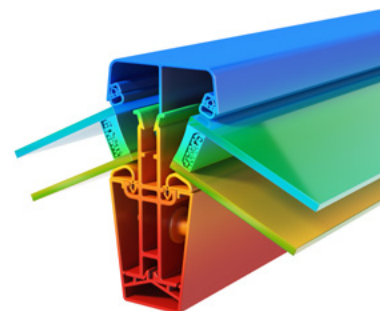



more Korniche products

Specify with confidence, secure in the knowledge that the Korniche products you choose will be the perfect finish for your project.

For more information about the full multi-award-winning Korniche product range, and details of 'Where to Buy' please scan the QR Code below:



Building Products Limited

Cemetery Works, Cemetery Road,
Radcliffe, Manchester, M26 4FT

t: 0161 300 4900

e: sales@pclbuildingproducts.co.uk



www.korniche.co.uk