

# skypod<sup>®</sup>

---

Eye-catching, affordable and easy  
to install pitched lantern roofs



**MADE & RECYCLED  
IN THE UK**





skypod®

PITCHED LANTERN ROOFS

## WHY CHOOSE SKYPOD?



Designed for superior performance



Fast, accurate installation



U-values as low as 1.0\*



20° fixed pitch



A choice of frame and glass colours



Cheaper than full aluminium alternatives



Kits delivered in 10 working days



10-year guarantee

There are lots of ways to add light to buildings, but none are as stylish as Skypod pitched lantern roofs

### Impress customers and end-users with desirable, space-enhancing lantern roofs

The Eurocell Skypod pitched lantern roof system enables you to create an eye-catching, contemporary feature that floods the interior of a property with natural light. It brings life and freshness to uninspiring flat-roofed buildings, and makes a stunning alternative to conventional conservatory roofs.

Skypod lantern roofs add height, light and volume to any living space. They are the perfect choice for a wide range of refurbishment, extension or new-build projects – including reception areas, classrooms, orangeries, kitchen-diners and garage conversions.

### Affordable, energy efficient and attractive – the perfect alternative to aluminium

Eurocell designed Skypod as an affordable alternative to aluminium skylights, making it accessible for more applications, to more people. As well as value issues, the ‘industrial’ aesthetic of aluminium skylights is unsuited to many properties and not to everyone’s taste.

Skypod offers significant energy-efficiency improvements, with a U-value as low as 1.0\* – helping your customers to save on their energy bills. The PVC-U cappings also help homeowners to match the appearance of their lantern roof to existing PVC-U windows and doors.

The architectural design means there are no fussy ridge crests or finials to fit, giving your customers the ultimate in clean sight-lines. A unique ridge end cover cap completes the sleek appearance.

### Create lantern roofs of any size, up to 2.75m x 8.7m

Skypod is available in a wide range of sizes, so you can create a lantern roof that’s suitable for any project. With a range of design options to choose from you can tailor Skypod to suit your customers’ individual needs.

### Simple, fast installation – for a quality-assured finish on every job

Crucially, Skypod has been designed for fast, accurate, simple installation. It requires only square cuts, with no mitring or awkward angles to negotiate, and all screw holes are pre-drilled. This enables installers to give customers a precision-fitted watertight lantern roof, while making the job as quick and easy as possible.

# MORE FLEXIBILITY

## A CHOICE OF CONTEMPORARY DESIGN



### Three-bar ridge end

The extra strength and rigidity of our 3-bar Skypod option not only allows you to install even longer, even wider vaulted rooflights into your customers' homes. It also gives a much more traditional 'orangery' style look to their rooflight, with the introduction of classically proportioned end panels in a spacious vaulted glass ceiling up 2.75m wide x 8.7m long in size.

### Skypod square

The alternative to a single span rectangular rooflight, our square lantern roof offers perfectly balanced sightlines and, thanks to its simple 4-hip design, higher levels of natural light than conventional designs of the same surface area. Because it can be produced in sizes right down to 0.5m x 0.5m, it means even the smallest flat roofed space in the home can benefit from day long natural light.



With this 3-bar ridge end design, you can create larger lantern roofs

### No side rafter bars

With the fewest possible number of slimline bars needed to create uninterrupted glazed surfaces of up to 1.5m x 2.75m, Skypod with no side rafter bars is the cleanest, simplest way to introduce overhead natural light into any room space. It offers a practically unobstructed window on the world above and, come rain or shine, keeps homeowners warm and comfortable thanks to its temperature controlling glass and high levels of energy efficiency.

### With side rafter bars

By introducing additional bars to the standard Skypod design, side rafter bars extend the possibilities for fully glazed rooflights to spans of up to 1.5m wide x 7.45m long. The result is a dazzling feature roof that turns what could so easily be an underwhelming flat roof extension into a year round living space with all the natural light and lofted headroom your customers could ever wish for.



Skypod with no side rafter bars

### skypod

Now you can give your customers a square lantern roof – with symmetrical looks!



# SKYPOD PLUS

## THE ALUMINIUM SKYPOD

### Architectural aesthetics with added protection against the elements

Building on the existing purpose designed thermally broken aluminium ridge and ring beam, Skypod Plus now offers aluminium rafter top caps. This means the whole of the external face not only offers stunning architectural aesthetics but also greater protection against the harsh summer mid-day sun. All internal bars are capped in the conventional way with PVC-U and are available in a black, white or grey finish.\*

Skypod Plus is available in 2 or 3 bar options and the square shape and is available in black, white and grey. The system has a fixed roof pitch of 20° and is supplied in a choice of five self-cleaning, temperature controlling glass options, with a centre pane U-value of 1.0W/m<sup>2</sup>K achievable.\*\*



Skypod Plus in Matt Black



Skypod Plus in Matt Black

The contemporary and balanced aesthetics on Skypod Plus have been achieved by avoiding the use of bulky end caps, crestings and finials, which are incorporated into skylights when using standard conservatory components.

Skypod Plus is available in two formats: kits from our kitting department and individual bar length components.



Skypod Plus in White both sides



Skypod Plus in Grey both sides

# EXCEPTIONAL STYLE & PERFORMANCE

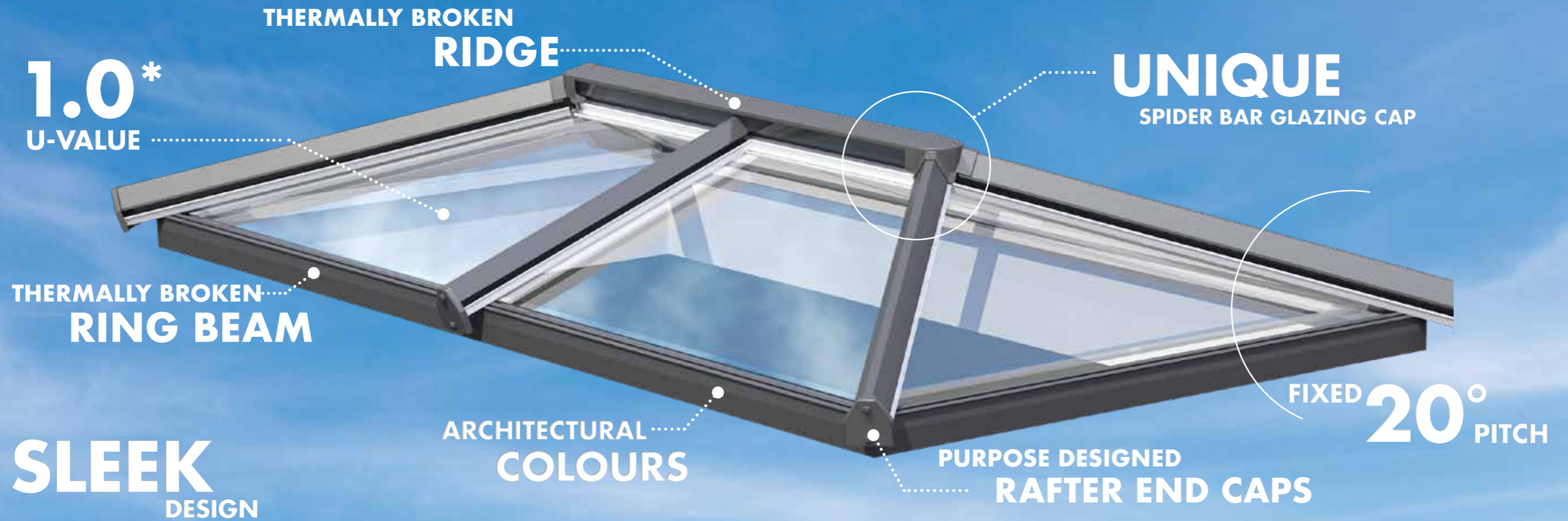

## New and improved

The Eurocell Skypod pitched lantern roof system has had further enhancements with the introduction of a more discreet internal boss, purpose designed and secure fix external rafter end caps and a thermally broken ring beam to create a virtually condensation free finish.

## Colours to frame the view

Like all Eurocell PVC-U products, Skypod comes with an exact colour-match guarantee. That means the colour is precisely matched to all Eurocell window, door and conservatory roof products, creating a co-ordinated, consistent look across any property.

Skypod has a white internal finish as standard, to maintain a bright, fresh interior. A range of external colours are available to complement existing architectural style, as well as a choice of glass options. Skypod Plus has a white internal finish, or an option of black or grey finish\*.

## Ten-year guarantee

Skypod lantern roofs are guaranteed for ten years. That means you can give your customers the assurance of a robust, well-designed, precision-made product that's built to last – manufactured by the UK's leading PVC-U specialist.

## SKYPOD FRAME COLOURS



## GLASS COLOURS



## SKYPOD PLUS FRAME COLOURS



ADDITIONAL COLOURS AND SPECIFICATIONS ARE MADE TO ORDER ON EXTENDED LEAD TIMES

### COMPONENTS

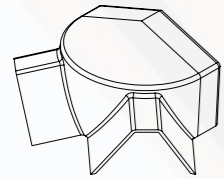

**CRS 9241**  
Skypod  
2-bar top cap

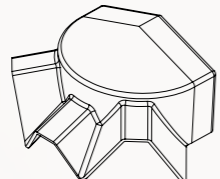

**CRS 9240**  
Skypod  
3-bar top cap

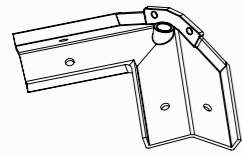

**CRS 9522A**  
Skypod  
2-bar spider bracket

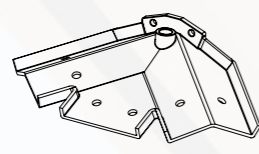

**CRS 9521A**  
Skypod  
3-bar spider bracket

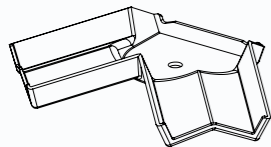

**CRS 9249**  
Skypod  
2-bar bottom cap

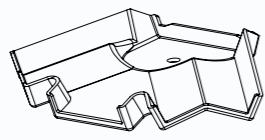

**CRS 9248**  
Skypod  
3-bar bottom cap

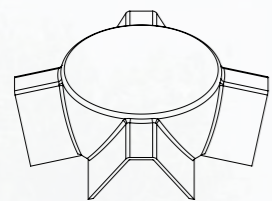

**CRS 9242**  
Skypod Square  
top cap

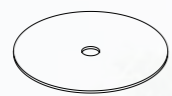

**CRS 9423**  
Skypod Square  
foam bung sealing plate

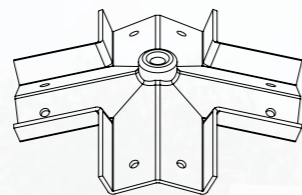

**CRS 9523A**  
Skypod Square  
spider bracket

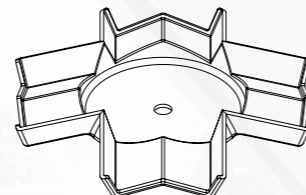

**CRS 9250**  
Skypod Square  
bottom cap

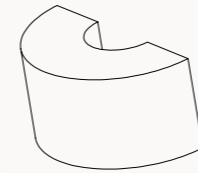
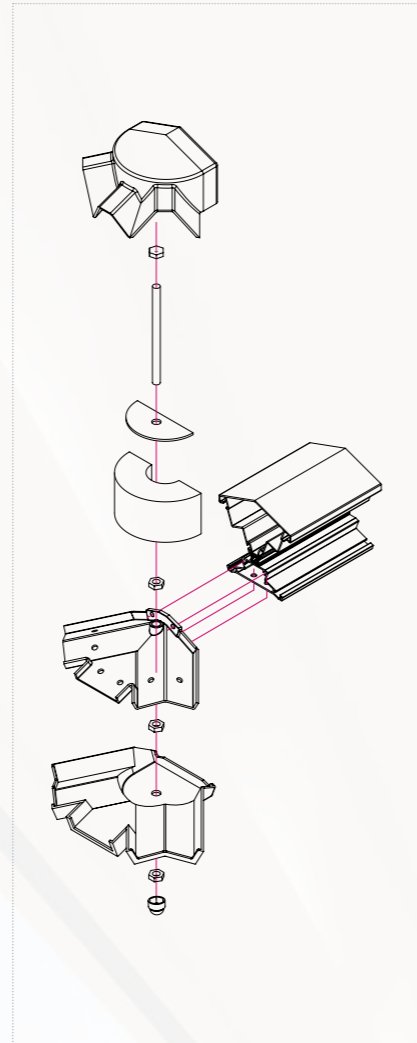

**CRS 9421**  
Skypod foam  
bung

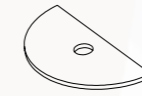

**CRS 9422A**  
Skypod foam bung  
sealing plate

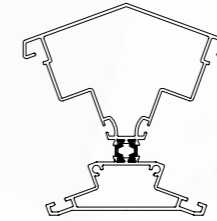

**CRS 9520A**  
Skypod ridge  
body



**CRS 8625**  
Single variable  
support stud

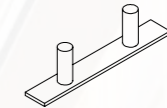

**CRS 8624**  
Double variable  
support stud



**CRS 9200**  
Skypod screw  
cap covers

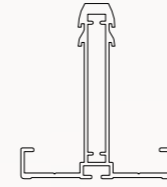

**CRS 8501A**  
Standard rafter



**CRS 8016**  
25mm  
rafter top cap



**CRS 8011**  
Rafter bottom cap

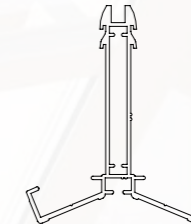

**CRS 8502A**  
Edwardian hip

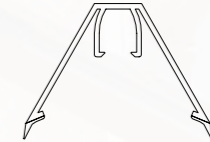

**CRS 8017**  
25mm Edwardian  
hip top cap



**CRS 8053**  
Eaves beam seal



**CRS 8056**  
25mm Glazing end trim

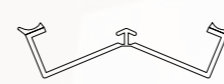

**CRS 8012**  
Hip bottom cap



**CRS 9550A**  
Skypod  
eaves 20°



**CRS 9552A**  
Skypod  
thermally broken eaves beam

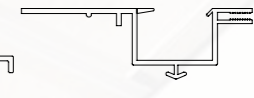

**CRS 8024**  
24/25mm ridge  
glazing trim

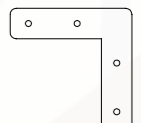

**CRS 8654**  
90° eaves  
beam cleat

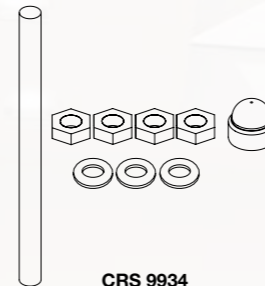

**CRS 9934**  
Skypod  
boss kit

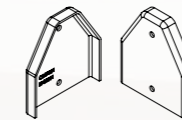

**CRS 9201**  
Skypod  
rafter end cap

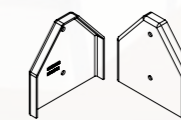

**CRS 9202**  
Skypod  
hip rafter end cap



**CRS 8211**  
Glazing stop  
(CRS 8628 Glazing  
stop screws)

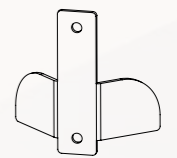

**CRS 9611S**  
Stainless steel glazing stop  
(CRS 8628 Glazing  
stop screws)

# TECHNICAL INFORMATION

## SYSTEM COMPONENTS

skypod<sup>PLUS</sup>  
PREMIUM LANTERN ROOFS

### COMPONENTS

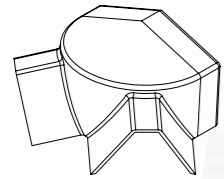

**CRS 9241**  
Skypod  
2-bar top cap

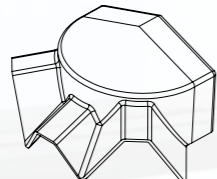

**CRS 9240**  
Skypod  
3-bar top cap

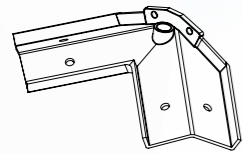

**CRS 9522A**  
Skypod  
2-bar spider bracket

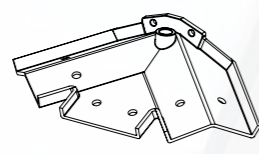

**CRS 9521A**  
Skypod  
3-bar spider bracket

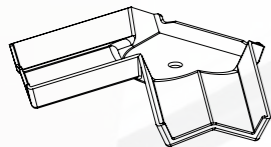

**CRS 9249**  
Skypod  
2-bar bottom cap

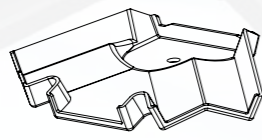

**CRS 9248**  
Skypod  
3-bar bottom cap

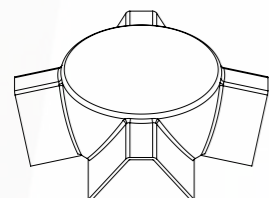

**CRS 9242**  
Skypod Square  
top cap

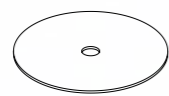

**CRS 9423**  
Skypod Square  
foam bung sealing plate

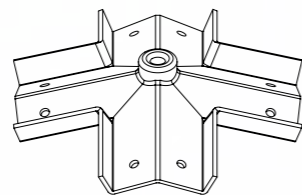

**CRS 9523A**  
Skypod Square  
spider bracket

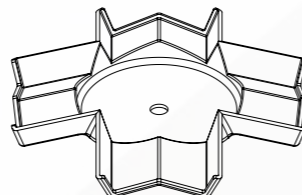

**CRS 9250**  
Skypod Square  
bottom cap

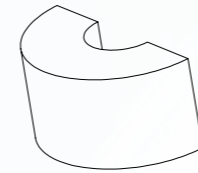
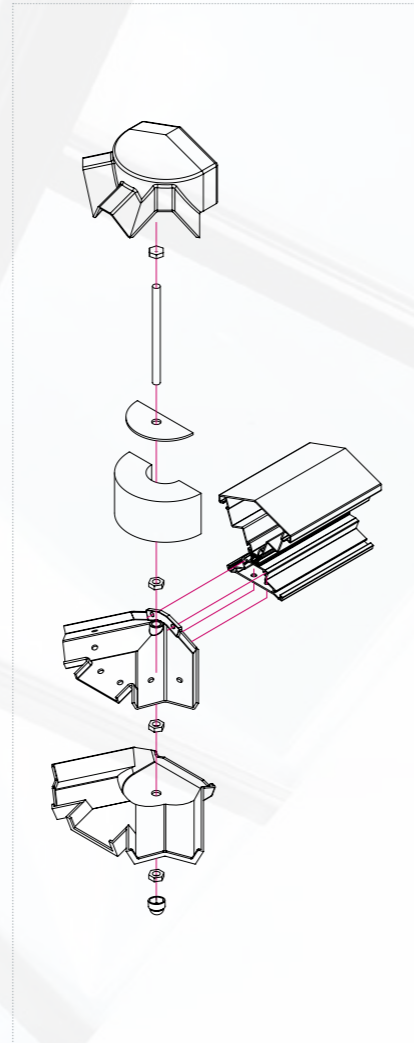

**CRS 9421**  
Skypod  
foam bung

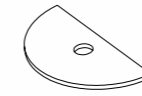

**CRS 9422A**  
Skypod  
foam bung sealing plate

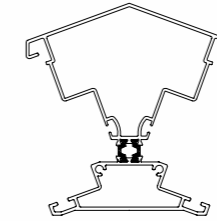

**CRS 9520A**  
Skypod  
ridge body



**CRS 8625**  
Single variable  
support stud

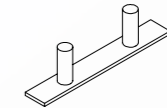

**CRS 8624**  
Double variable  
support stud



**CRS 9200**  
Skypod  
screw cap covers

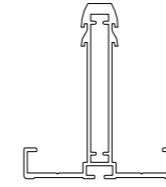

**CRS 8501A**  
Standard rafter

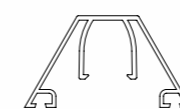

**CRS 8516A**  
Skypod Plus  
aluminium rafter top cap

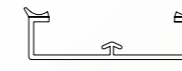

**CRS 8011**  
Rafter bottom cap

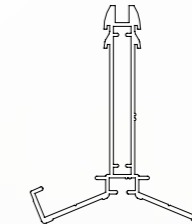

**CRS 8502A**  
Edwardian hip

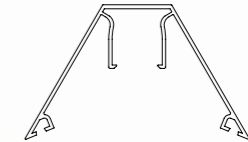

**CRS 8517A**  
Skypod Plus  
aluminium hip top cap



**CRS 8053**  
Eaves beam seal

25mm glazing  
end trim  
**CRS 8056**



**CRS 8056**  
25mm Glazing end trim



**CRS 8012**  
Hip bottom cap



**CRS 9550A**  
Skypod  
eaves 20°



**CRS 9552A**  
Skypod  
thermally broken eaves beam



**CRS 8024**  
24/25mm ridge  
glazing trim

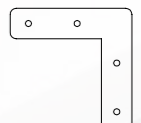

**CRS 8654**  
90° eaves  
beam cleat



**CRS 9934**  
Skypod  
boss kit

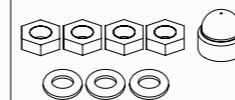

**CRS 8010**  
Skypod Plus  
thermal break for  
aluminium top caps



**CRS 8411G**  
Skypod Plus  
aluminium top gasket

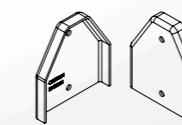

**CRS 9201**  
Skypod  
rafter end cap

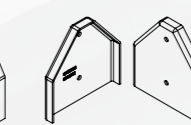

**CRS 9202**  
Skypod  
hip rafter end cap



**CRS 8211**  
Glazing stop  
(CRS 8628 Glazing  
stop screws)

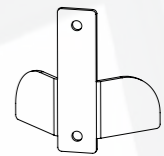

**CRS 9611S**  
Stainless steel glazing stop  
(CRS 8628 Glazing  
stop screws)

# TECHNICAL INFORMATION

## ASSEMBLIES

### 20° SKYPOD/SKYPOD PLUS

#### Ridge assembly

Powder-coated aluminium, thermally broken

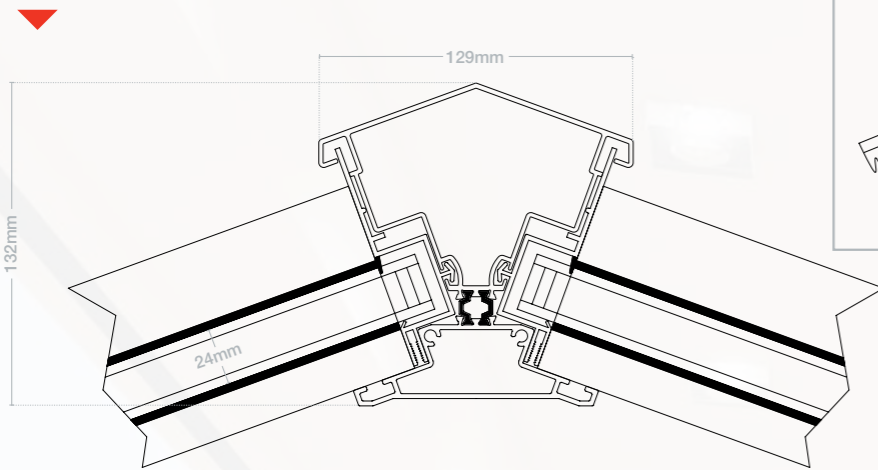

#### skypod<sup>PLUS</sup> Hip assembly

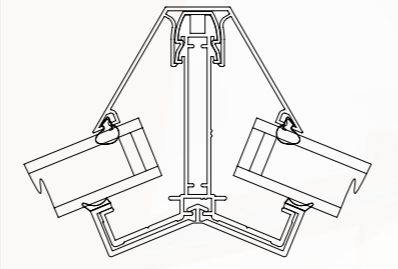

#### Hip assembly

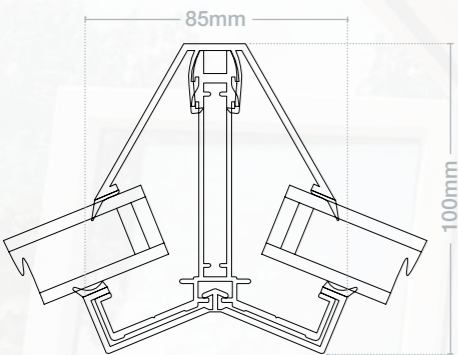

#### Ring beam on kerb assembly

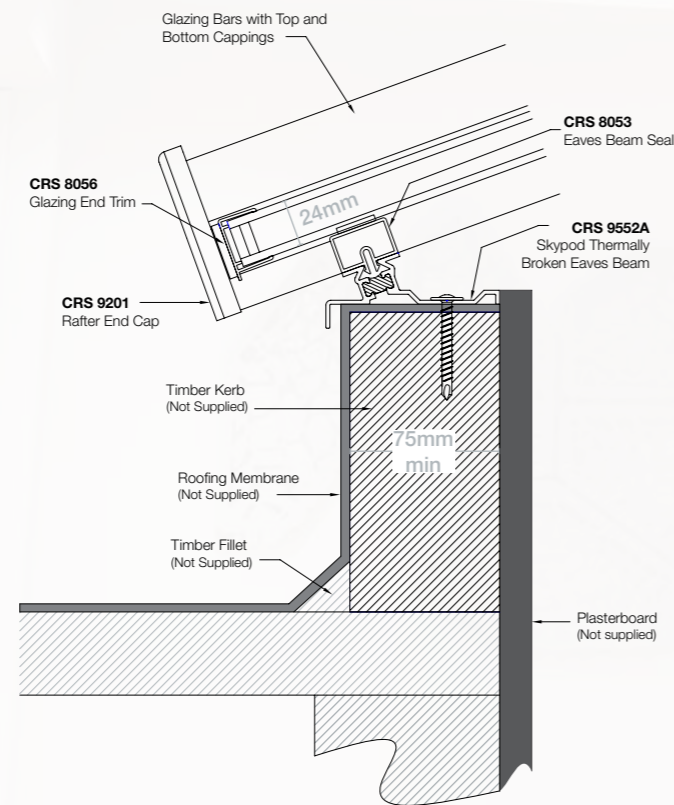

#### Rafter assembly

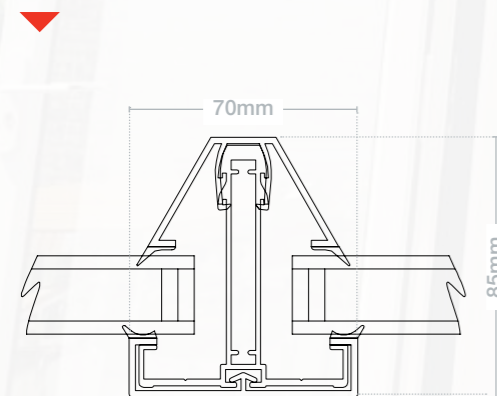

# TECHNICAL INFORMATION

## MINIMUM & MAXIMUM SIZES



No 'side-bars' needed on sizes up to 1.5m x 2.75m



Up to 1.5m x 7.45m

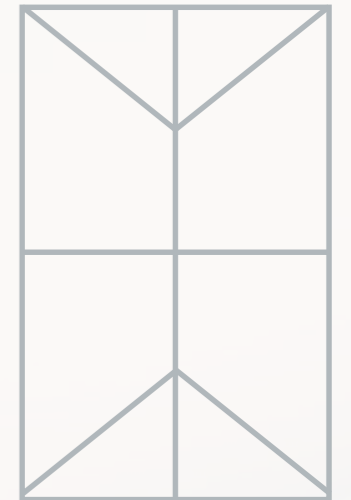

Up to 2.75m x 8.7m

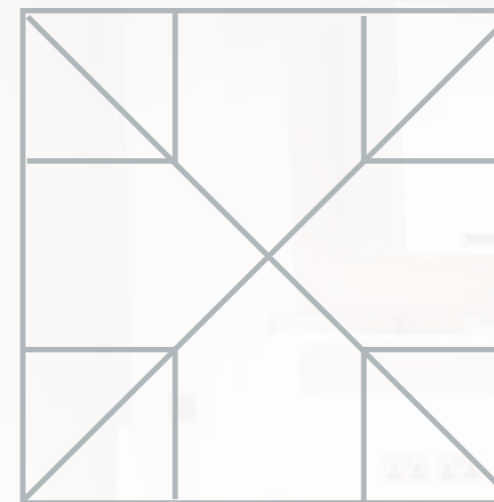

Up to 2.75m x 2.75m



Up to 1.5m x 1.5m

**Note:** Design will vary dependent on size. All Skypod lantern roofs are made-to-order, and you will receive a design to sign-off before the item goes into production.





**PCL Building Products Limited**  
Cemetery Works, Cemetery Road,  
Radcliffe, Manchester, M26 4FT  
t: 0161 300 4900  
e: [quotes@pclbuildingproducts.co.uk](mailto:quotes@pclbuildingproducts.co.uk)  
w: [www.pclbuildingproducts.co.uk](http://www.pclbuildingproducts.co.uk)